

Operating Instructions

Type 70 High Pressure Switching Valves

Model 7010 Sample Injector

1.0 DESCRIPTION

Rheodyne's Type 70 valves are high pressure switching valves: 7000, 7000L, 7030, 7030L, 7040, 7040L, 7060 and 7060L. Unless otherwise indicated, statements about non-L models apply also to the L models.

Model 7010 is a sample injector. An accessory Loop Filler Port (P/N 7012) or Needle Port (P/N 9013) is needed to load sample into Model 7010.

Figure 1 shows a schematic flow diagram of each of the switching valves. The circles represent the ports in the valve stator. The dark grooves are the connecting passages in the rotor seal.

Rotation of the valve shaft through 60° switches the valve from one position to the other. Models 7010, 7000, 7030, and 7040 are two-position valves with stops that restrict the rotation of the valve to 60° turns. Model 7060 is a six-position valve. A spring-loaded detent mechanism is included which allows continuous rotation and insures that the shaft "falls into" each of the six positions at the precise 60° spacing.

2.0 SUPPLIED WITH THE VALVE

Supplied with the valve in a separate bag are RheFlex® stainless steel fittings sets for all ports and the following items. A 20 µL sample loop is supplied with Model 7010. A jumper loop is supplied with Model 7040.

- Hex Key(s)
- Mounting Screws (2)

3.0 SPECIFICATIONS

- Maximum Operating Pressure: Model 7010 and Type 70 non-L models - 48 MPa (483 bar, 7000 psi); L models - 34 MPa (345 bar, 5000 psi)
- Maximum Operating Temperature: Models 7010, 7000, 7030, 7040, and L models - 150°C; Model 7060 - 80°C
- Flow Passage Diameters: Models 7010, 7000, 7030, 7040 - 0.5 mm (0.018") and 0.6 mm (0.024"); Model 7060 - 0.5 mm (0.018") and 0.4 mm (0.016"); L models - 1 mm (0.040")
- Wetted Surfaces: stainless steel and an inert polymer
- Ports in all models accept 10-32 male threaded fittings

4.0 IMPORTANT SAFETY NOTICES

4.1 Warning: (Using 7010 as an injector): When using sample loops larger than 100 µL, shield yourself from mobile phase coming out of the needle port when the valve is turned from INJECT to LOAD. Example: 1 mL loop ejects 20 µL upon decompression from 19 MPa (200 bar, 2898 psi).

4.2 Caution: Do not mount the valve with the ports facing up. Leakage due to a damaged rotor seal or loose fittings can cause the bearings to corrode.

4.3 Caution: Rinse the valve thoroughly after using buffer solutions to prevent salt crystals from forming, which can cause damage to the rotor seal and stator face assembly.

5.0 INSTALLATION

- All valves can be panel mounted:
- Remove the handle assembly by loosening the knob set screw(s).
 - Fasten the valve to the panel using the two mounting screws supplied.
- On Model 7060, the two screws that hold the detent mechanism on the valve should be removed before fastening the valve to the panel.

5.1 MODEL 7010 INJECTOR

- Using model 7010 as a sample injector:
- Connect a loop filler port or injection port to Port 5 and the vent line to Port 6. Place the injection port at the same horizontal level as Vent Line 6 to avoid siphoning.
 - Connect the pump to Port 2 and the column to Port 3. Leave the column disconnected from the valve during initial flushing.

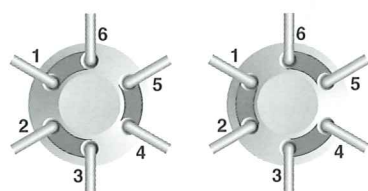

Position A Position B

Position A Position B

Models 7000 & 7010
Two-Position, Six-Port

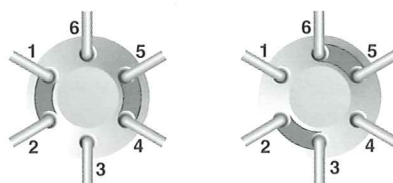

Position A Position B

Position A Position B

Model 7030
Three-Way

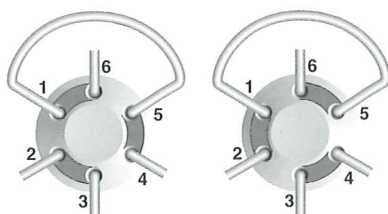

Position A Position B

Model 7040
Four-Way

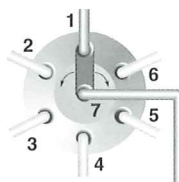

Model 7060
Six-Position

Fig. 1. Flow diagrams of Rheodyne Type 70 high pressure switching valves.

6.0 OPERATION

6.1 INJECTIONS (MODEL 7010 ONLY)

Before connecting the column to the injector, flush the injector with mobile phase in both the LOAD and INJECT positions. After flushing the injector, turn to LOAD, and connect the column.

6.1.1 LOADING THE SAMPLE LOOP

Overfill the loop with at least two to five loop volumes of sample. Six to ten loop volumes will provide even better precision. An excess of sample is needed because mobile phase near the wall of the loop is displaced slowly due to the laminar flow effect shown in Figure 2.

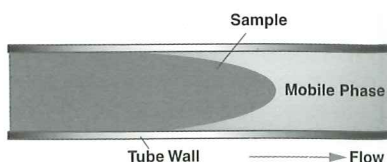

Fig. 2. Laminar flow effect.

To completely fill the loop (see Figure 3):

- See **Warning 4.1** and turn to LOAD.
- Insert the syringe into the accessory injection port.
- Load the sample.
- Leave the syringe in position and turn to INJECT.

6.2 SUGGESTED APPLICATIONS FOR SWITCHING VALVES

Flush the valve with mobile phase before connecting the valve to system components.

Suggested applications for switching valve applications are shown in Figures 7, 8, 9, and 10.

7.0 ADJUSTING FOR LEAKAGE OR HIGHER PRESSURE OPERATION

The three small set screws in the stator (see Figure 4) have been factory set so that when the three stator screws are fully tightened, the spring force between the valve rotor and stator is sufficient to hold the indicated pressure. If leakage is to be corrected, or if operation at a higher pressure is to be done, proceed as follows: The three set screws should be loosened about 1/20 turn each (18° of rotation) and the three stator screws tightened an equal amount. If this new setting fails to accomplish leak-free operation at the desired pressure, repeat the procedure by an additional 1/20 turn. Avoid excessive tightening which will only increase wear of the rotor seal. If it is necessary to loosen spring tension, either to lower the operating pressure, or to adjust for a new rotor seal, which may be thicker than the one being replaced, reverse the above procedures. For example, first loosen the stator screws, then tighten the set screws.

If leakage cannot be stopped by tightening the valve, or if, as a result of tightening to

stop the leakage, the handle is too hard to turn, the rotor seal needs replacing. See next section.

8.0 MAINTENANCE

Parts that may need eventual replacement are the rotor seal and isolation seal. Abrasive particles in the sample can damage the rotor seal. Replacement stators are also available.

Genuine Rheodyne parts are easily replaced by the following instructions.

8.1 DISASSEMBLY

To disassemble the valve, refer to Figure 4 and proceed as follows:

- Remove the three stator screws.
- Remove stator and stator ring from valve body.
- Pull the rotor seal off of the pins.
- Remove the isolation seal.

8.2 REASSEMBLY

8.2.1 TWO-POSITION VALVE REASSEMBLY

To reassemble Models 7010, 7000, 7030, and 7040, refer to Figures 4 and 6 and proceed as follows:

- Mount the new isolation seal onto the shaft with the open side facing the stator.
- Be sure that the rotor seal is correctly oriented as shown in Figure 6 with rotor seal grooves facing the stator and with the notch in the metal rim of the rotor seal in line as shown (the notch also faces the stator).
- In replacing the stator ring, be sure that the two stop pins are still in their holes in the stator ring, then push the stator ring squarely onto the shaft assembly allowing the stop pins to enter the mating holes in the body. Be sure the rotor pin is located between the two stop pins (Model 7060 does not have a rotor pin so the rotor can be in any position).

d) Replace the stator by first pushing it onto the two pins on the stator ring and then adding the three stator screws. Tighten each screw a little at a time to keep the stator surface parallel to the stator ring surface. If the three set screws in the stator were left unchanged, tighten the three stator screws a 1/2 turn past fingertight. The three set screws will ensure that the gap between stator and stator ring is uniform and in the original position before disassembly.

e) If the set screws need adjusting because a new rotor seal was installed or because leakage has to be stopped, each set screw should be turned an equal amount to ensure that after the stator screws are retightened, the gap between the stator and stator ring is uniform all around. Refer also to Section 7.0.

8.2.2 MODEL 7060 REASSEMBLY

An arrow has been engraved on the knob end of the shaft. Orient the rotor seal on the rotor as shown in Figure 6 relative to this arrow (with the grooves in the rotor seal facing the stator).

Follow the steps in Section 8.2.1.

8.3 ATTACHING HANDLE

The knob for the Model 7060 has a single set screw located opposite the black handle. The knob should be oriented on the Model 7060 shaft so that the knob pointer points in the same direction as the arrow on the end of the shaft. The set screw should be tightened on the flat of the shaft with the tip of the set screw centered on the hole in the shaft. Confirm this centering before final tightening of the set screw.

The knob for the two-position valves has two set screws, both at 90° from the black handle. It is best to tighten only the one set screw on the flat of the shaft although both set screws can be tightened. Confirm that the set screw tip is centered on the hole in the shaft before tightening (remove one set screw to observe alignment while tightening the other).

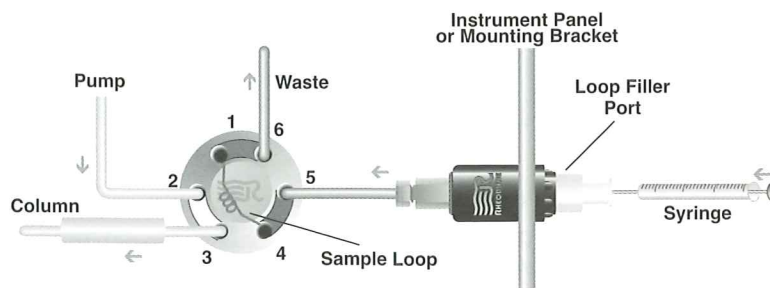

Fig. 3. Using a Loop Filler Port to fill the loop by pressure loading.

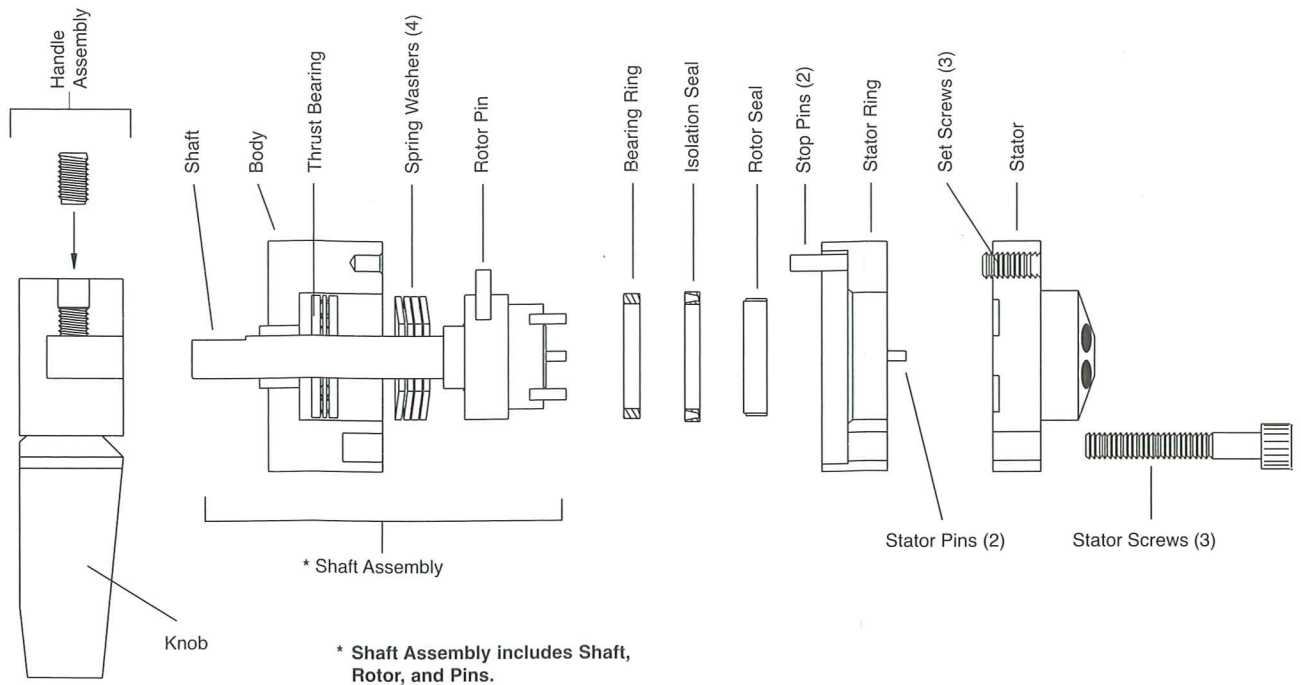

Fig. 4. Exploded view of Type 70 valves.

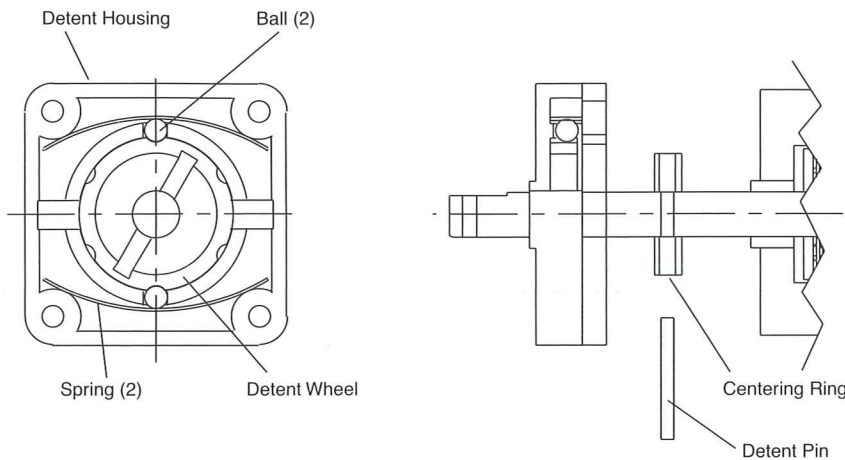

Fig. 5. Detent mechanism on Model 7060.

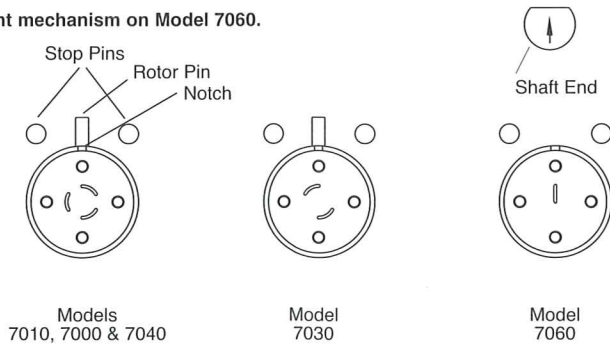

Fig. 6. Correct rotor seal orientation (viewed from stator).

8.4 DETENT MECHANISM ON MODEL 7060

If mounting Model 7060 on an actuator, the detent mechanism must be disabled (refer to Figure 5):

- a) Remove the detent pin and centering ring.
- b) Push the detent pin into the holes in the centering ring and the shaft.

c) Center the pin, making each end project equally from the ring OD.

d) Rotate the body while pushing the detent body in place to allow the detent pin to fall into the two notches in the detent wheel.

e) Rotate the body while holding the detent body in place to allow the mounting holes to line up with the threaded mounting holes in the valve body.

9.0 OPERATING SUGGESTIONS

9.1 USE OF AQUEOUS BUFFERS OR SALT SOLUTIONS

To prevent the formation of salt crystals in the valve, flush out the flow passages with water after using salt solutions.

9.2 USE OF HIGH pH SOLUTIONS

The standard rotor seal is Vespel¹, which has exceptionally good wear resistance. However, Vespel is susceptible to alkaline attack, deteriorating rapidly when used with solutions of pH over 10. PEEK and Tefzel¹ rotor seals are available for alkaline applications.

9.3 ACCURACY OF SAMPLE LOOPS

Sample loop sizes are not actual values. The actual volume can differ by $\pm 10\%$ for a 20 μL loop and $\pm 5\%$ for a 10 mL loop. There is a greater difference for smaller loops.

10.0 RECOMMENDED SPARE PARTS

Parts that may need replacement are the rotor seal, isolation seal, and stator. Genuine Rheodyne® rotor seals are easily replaced by following the instructions in Section 8.0.

Table I shows the Rheodyne part numbers for the replacement rotor seals:

Table I.

Model	Standard Models	L Models
7000 and 7040	7010-039	7000-016
7030	7030-003	7030-014
7060	7060-070	7060-064

A convenient alternative to separate replacement part ordering is the Rheodyne RheBuild® Kit for Models 7010, 7000 and 7040. The RheBuild Kit includes all necessary parts, tools, and instructions to maintain the quality performance of your Rheodyne valve.

7010-999 RheBuild Kit for 7010, 7000, and 7040.

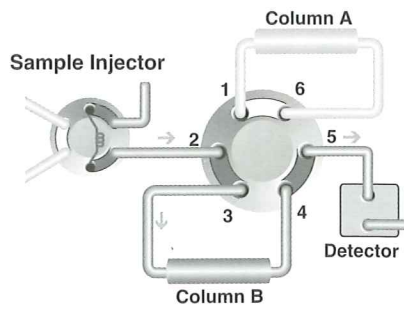

Position A

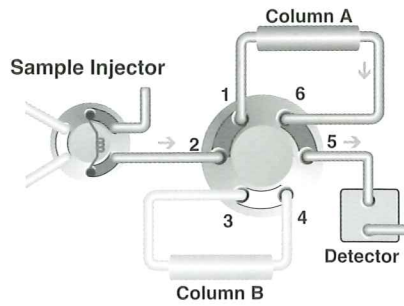

Position B

Fig. 7. Two column selection using Model 7000.

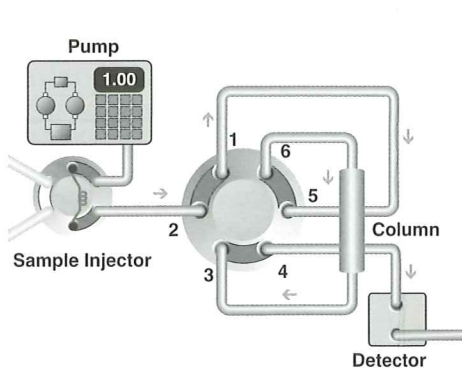

Position A (Forward Flow)

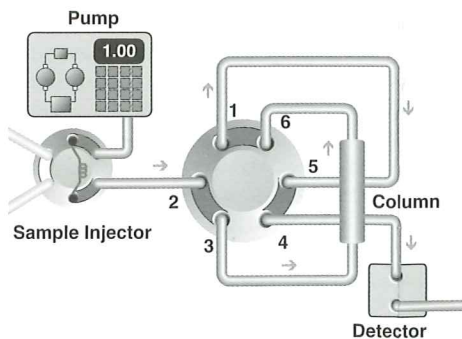

Position B (Reverse Flow)

Fig. 8. Illustration of column flow reversal for backflushing using Model 7040.

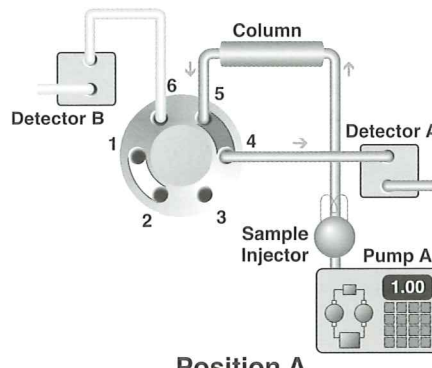

Position A

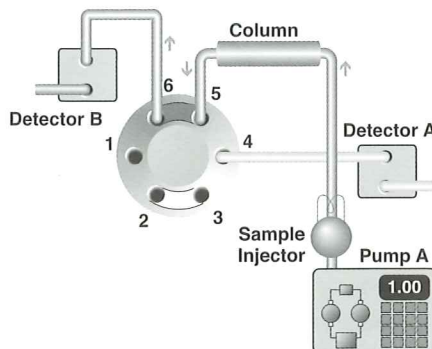

Position B

Fig. 9. Diverting flow from one detector to the other using Model 7030.

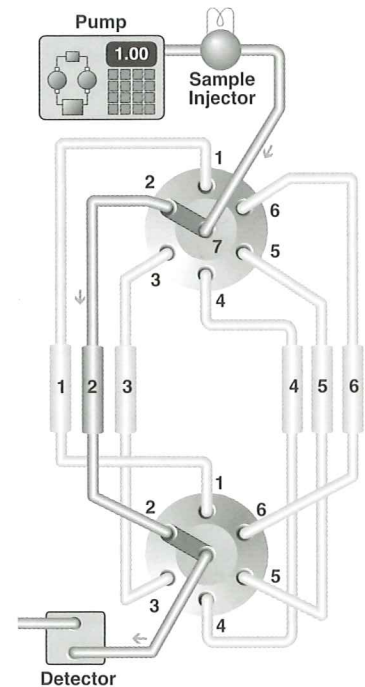

Fig. 10. Six column selection using two Model 7060 switching valves.

¹ Tefzel and Vespel are trademarks of E.I. DuPont.